



■ Features

- 180~295VAC input range
- Built-in active PFC function
- No load power consumption <0.5W
- High efficiency up to 91%
- Fanless design, cooling by free air convection
- IP67 / IP65 design for indoor or outdoor installations
- Output current adjustable through output cable or internal potentiometer for A-Type
- Built-in 3 in 1 dimming function for B-Type (0~10Vdc or 10V PWM signal or resistance)
- Protections: Short circuit / Overload / Over voltage / Over temperature
- Class 2 power unit
- Suitable for dry / damp / wet locations
- Type “HL” for use in class I , Division 2 hazardous(Classified) location luminaires
- 5 years warranty(Note.8)

■ Applications

- LED street lighting
- LED harbor lighting
- LED bay lighting
- LED greenhouse lighting
- Class I , Division 2 hazardous (Classified) location luminaires

■ Description

ELG-100 series is a 100W LED AC/DC power supply featuring the constant current output and constant voltage output design with low output voltage. The input accepts the wide range 180~295VAC and is equipped with the active PFC function. With the high efficiency up to 91% and the heat-conducted silicone, ELG-100 is able to operate for -40°C~+90°C case temperature under free air convection.

■ Model Encoding

ELG - 100 - 36 A

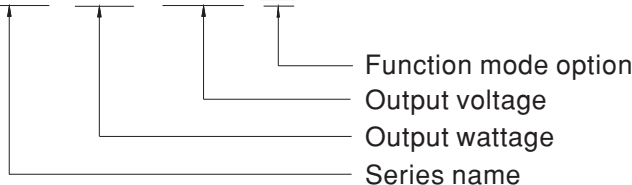

- Blank : Standard model, IP67, constant current and constant voltage levels fixed
- A : Standard model, IP65, constant current and constant voltage levels adjustable through internal potentiometer
- B : Standard model, IP67, constant current level adjustable with additive 0~10Vdc, 10V PWM signal or resistance
- D: Optional model, IP67, Smart timer dimming function. Please contact MEAN WELL for details
- DA: Optional model, IP67, DALI function



SPECIFICATION

MODEL		ELG-100-24□	ELG-100-36□	ELG-100-42□	ELG-100-48□	ELG-100-54□
OUTPUT	DC VOLTAGE	24V	36V	42V	48V	54V
	CONSTANT CURRENT REGION <small>Note.4</small>	12 ~ 24V	18 ~ 36V	21 ~ 42V	24 ~ 48V	27 ~ 54V
	RATED CURRENT	4.0A	2.66A	2.28A	2A	1.78A
	RATED POWER	96W	95.76W	95.76W	96W	96.12W
	RIPPLE & NOISE (max.) <small>Note.2</small>	200mVp-p	250mVp-p	250mVp-p	300mVp-p	350mVp-p
	VOLTAGE ADJ. RANGE	Can be adjusted by internal potentiometer for A-Type only				
		21.6 ~ 26.4V	32.4 ~ 39.6V	37.8 ~ 46.2V	43.2 ~ 52.8V	48.6 ~ 59.4V
	CURRENT ADJ. RANGE	Can be adjusted by internal potentiometer for A-Type only				
		2 ~ 4A	1.33 ~ 2.66A	1.14 ~ 2.28A	1 ~ 2A	0.89 ~ 1.78A
	VOLTAGE TOLERANCE <small>Note.3</small>	±3.0%	±2.5%	±2.5%	±2.0%	±2.0%
	LINE REGULATION	±0.5%	±0.5%	±0.5%	±0.5%	±0.5%
	LOAD REGULATION	±1.0%	±1.0%	±0.5%	±0.5%	±0.5%
	SETUP, RISE TIME <small>Note.6</small>	500ms, 100ms at 95% load 230VAC				
HOLD UP TIME (Typ.)	10ms at 95% load 230VAC					
INPUT	VOLTAGE RANGE <small>Note.5</small>	180 ~ 295VAC				
	FREQUENCY RANGE	47 ~ 63Hz				
	POWER FACTOR	PF ≥ 0.95/230VAC PF ≥ 0.92/277VAC at full load (Please refer to "Power Factor Characteristic curve")				
	TOTAL HARMONIC DISTORTION	THD < 20% when output loading ≥ 50% at 230VAC input and output loading ≥ 75% at 277VAC input				
	EFFICIENCY (Typ.)	88%	89%	90%	90%	91%
	AC CURRENT	0.6A / 230VAC 0.5A/277VAC				
	INRUSH CURRENT(Typ.)	COLD START 60A(twidth=850μs measured at 50% Ipeak) at 230VAC				
	MAX. No. of PSUs on 16A CIRCUIT BREAKER	3 units (circuit breaker of type B) / 6 units (circuit breaker of type C) at 230VAC				
	LEAKAGE CURRENT	<0.75mA / 277VAC				
PROTECTION	OVER CURRENT	95 ~ 108% Protection type : Constant current limiting, recovers automatically after fault condition is removed				
	SHORT CIRCUIT	Hiccup mode, recovers automatically after fault condition is removed				
	OVER VOLTAGE	28 ~ 34V	41 ~ 48V	47 ~ 54V	54 ~ 62V	62 ~ 72V
		Protection type : Shut down o/p voltage, re-power on to recovery				
OVER TEMPERATURE	Shut down o/p voltage, re-power on to recovery					
ENVIRONMENT	WORKING TEMP.	Tcase=-40 ~ +90°C (Refer to "Derating Curve")				
	MAX. CASE TEMP.	Tcase=+90°C				
	WORKING HUMIDITY	20 ~ 95% RH non-condensing				
	STORAGE TEMP., HUMIDITY	-40 ~ +80°C, 10 ~ 95% RH				
	TEMP. COEFFICIENT	±0.03%/°C (0 ~ 60°C)				
VIBRATION	10 ~ 500Hz, 5G 12min./1cycle, period for 72min. each along X, Y, Z axes					
SAFETY & EMC	SAFETY STANDARDS	UL8750(type"HL"), EN61347-1, EN61347-2-13 independent, EN62384,IP65 or IP67 approved				
	WITHSTAND VOLTAGE	I/P-O/P:3.75KVAC I/P-FG:2.0KVAC O/P-FG:1.5KVAC				
	ISOLATION RESISTANCE	I/P-O/P, I/P-FG, O/P-FG:100M Ohms / 500VDC / 25°C / 70% RH				
	EMC EMISSION	Compliance to EN55015,EN61000-3-2 Class C (≥ 50% loading) ; EN61000-3-3				
	EMC IMMUNITY	Compliance to EN61000-4-2,3,4,5,6,8,11; EN61547, light industry level (surge 6KV)				
OTHERS	MTBF	282.9Khrs min. MIL-HDBK-217F (25°C)				
	DIMENSION	199*63*35.5mm (L*W*H)				
	PACKING	0.75kg; 16pcs/13kg/0.72CUFT				
NOTE	<ol style="list-style-type: none"> All parameters NOT specially mentioned are measured at 230VAC input, rated load and 25°C of ambient temperature. Ripple & noise are measured at 20MHz of bandwidth by using a 12" twisted pair-wire terminated with a 0.1uf & 47uf parallel capacitor. Tolerance : includes set up tolerance, line regulation and load regulation. Please refer to "DRIVING METHODS OF LED MODULE". Derating may be needed under low input voltages. Please check the static characteristics for more details. Length of set up time is measured at cold first start. Turning ON/OFF the power supply may lead to increase of the set up time. The power supply is considered as a component that will be operated in combination with final equipment. Since EMC performance will be affected by the complete installation, the final equipment manufacturers must re-qualify EMC Directive on the complete installation again. Refer to warranty statement. 					

■ Block Diagram

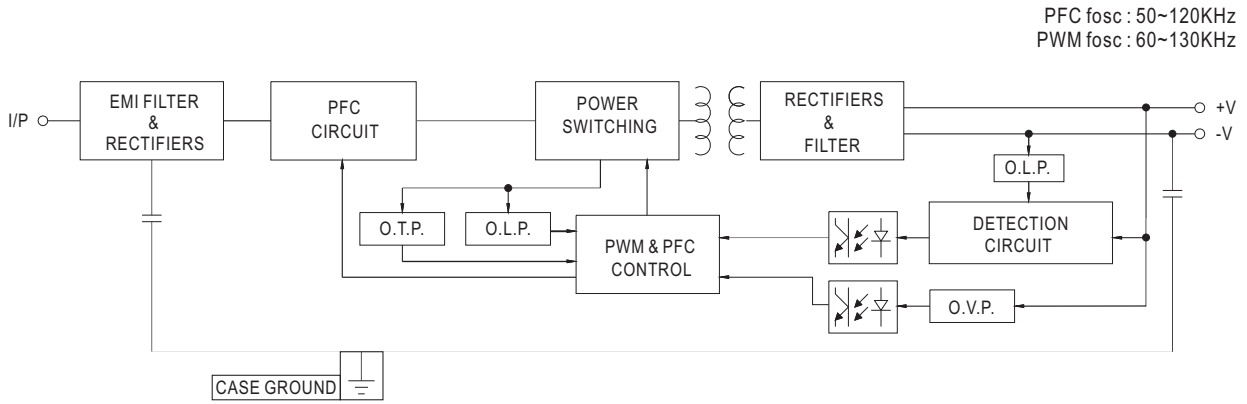

■ Derating Curve

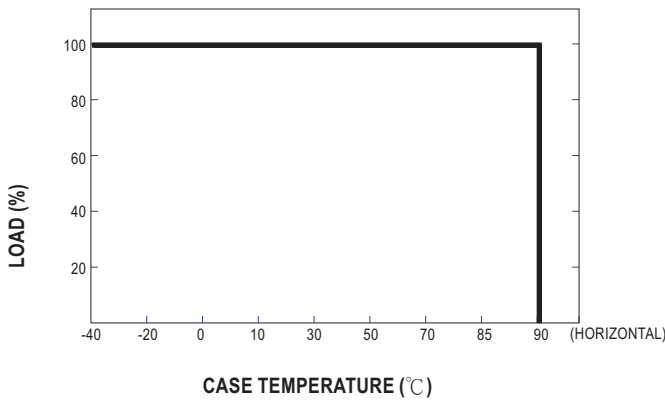

■ Static Characteristics

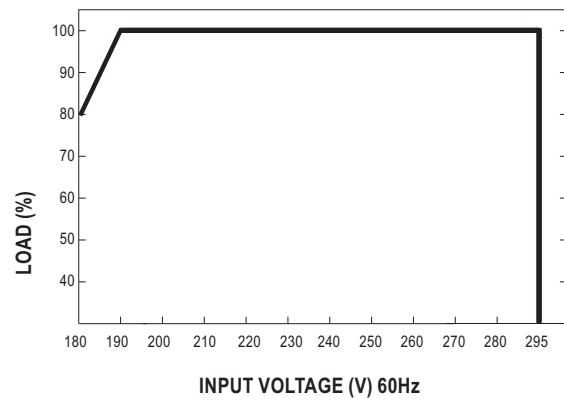

Power Factor Characteristic

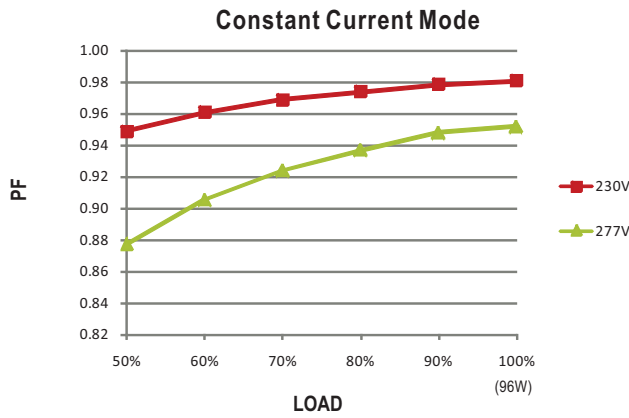

EFFICIENCY vs LOAD (54V Model)

ELG-100 series possess superior working efficiency that up to 91% can be reached in field applications.

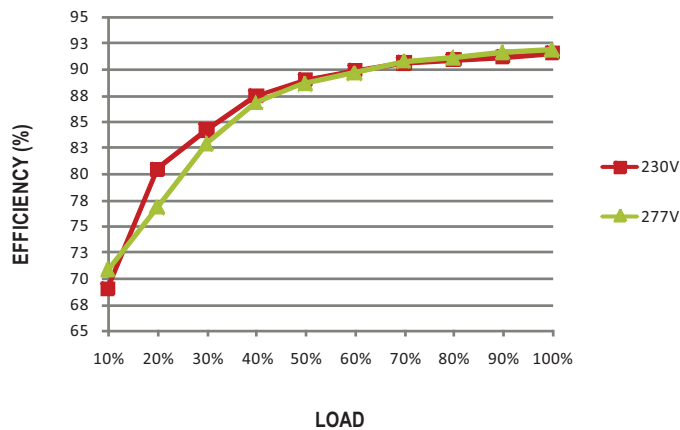

DRIVING METHODS OF LED MODULE

There are two major kinds of LED drive method, "direct drive" and "with LED driver".

A typical LED power supply may either work in "constant voltage mode (CV)" or "constant current mode (CC)" to drive the LEDs.

Mean Well's LED power supply with CV+ CC characteristic can be operated at both CV mode (with LED driver, at area (A) and CC mode (direct drive, at area (B)).

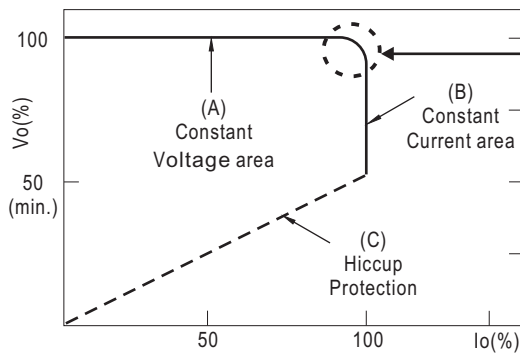

Typical LED power supply I-V curve

In the constant current region, the highest voltage at the output of the driver depends on the configuration of the end systems.

Should there be any compatibility issues, please contact MEAN WELL.

■ DIMMING OPERATION(for B-Type only)

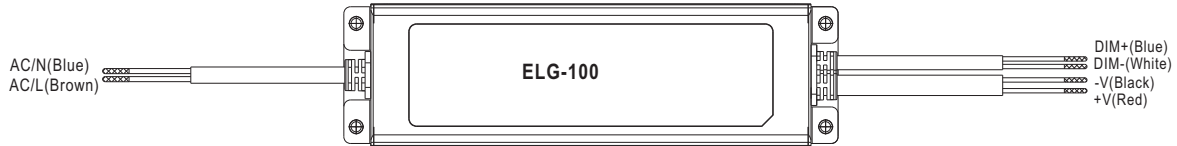

※ Built-in 3 in 1 dimming function, IP67 rated. Output constant current level can be adjusted through output cable by connecting a resistance or 0 ~ 10Vdc or 10V PWM signal between DIM+ and DIM-.

※ Please DO NOT connect "DIM-" to "-V".

※ Reference resistance value for output current adjustment (Typical)

Resistance value	Single driver	Short	10K Ω	20K Ω	30K Ω	40K Ω	50K Ω	60K Ω	70K Ω	80K Ω	90K Ω	100K Ω	OPEN
	Multiple drivers (N=driver quantity for synchronized dimming operation)	Short	10K Ω /N	20K Ω /N	30K Ω /N	40K Ω /N	50K Ω /N	60K Ω /N	70K Ω /N	80K Ω /N	90K Ω /N	100K Ω /N	-----
Percentage of rated current		0%	10%	20%	30%	40%	50%	60%	70%	80%	90%	100%	95%~108%

※ 0 ~ 10V dimming function for output current adjustment (Typical)

Dimming value	0V	1V	2V	3V	4V	5V	6V	7V	8V	9V	10V	OPEN
Percentage of rated current	0%	10%	20%	30%	40%	50%	60%	70%	80%	90%	100%	95%~108%

※ 10V PWM signal for output current adjustment (Typical): Frequency range : 100Hz ~ 3KHz

Duty value	0%	10%	20%	30%	40%	50%	60%	70%	80%	90%	100%	OPEN
Percentage of rated current	0%	10%	20%	30%	40%	50%	60%	70%	80%	90%	100%	95%~108%

◎ Dimming Characteristic

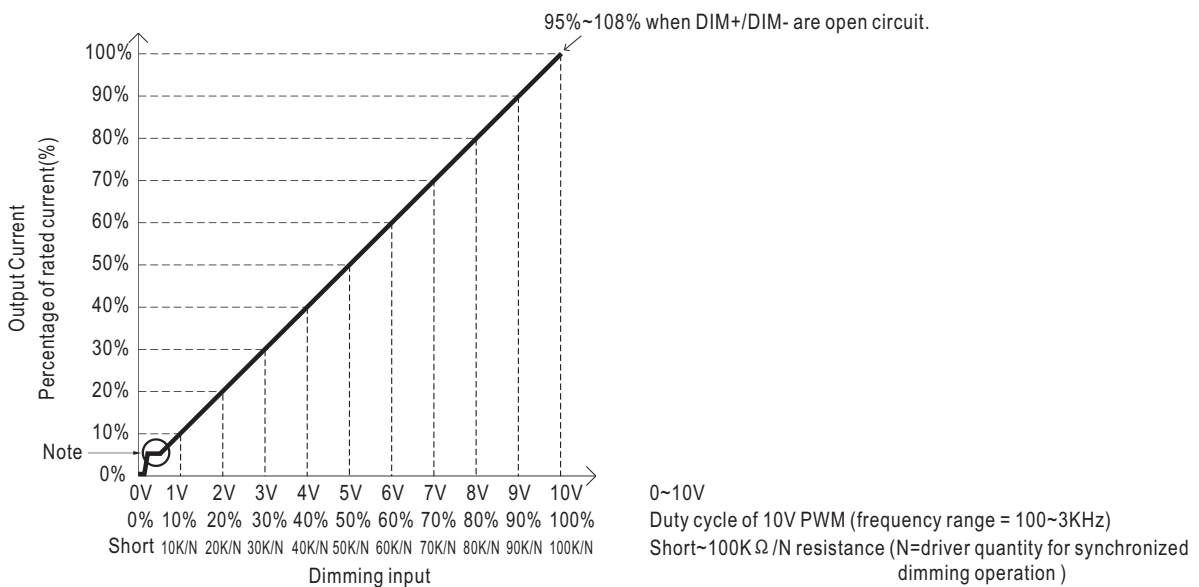

- ※ Note : 1. Min. dimming level is about 6%
- 2. The output current is not defined when 0%<I_{out}<6%
- 3. The output current could drop down to 0% when dimming input is about 0K Ω or 0Vdc, or 10V PWM signal with 0% duty cycle

■ Mechanical Specification

CASE NO.: 244A Unit:mm

Blank-Type/D-Type:(ELG-100-_,ELG-100-_D)

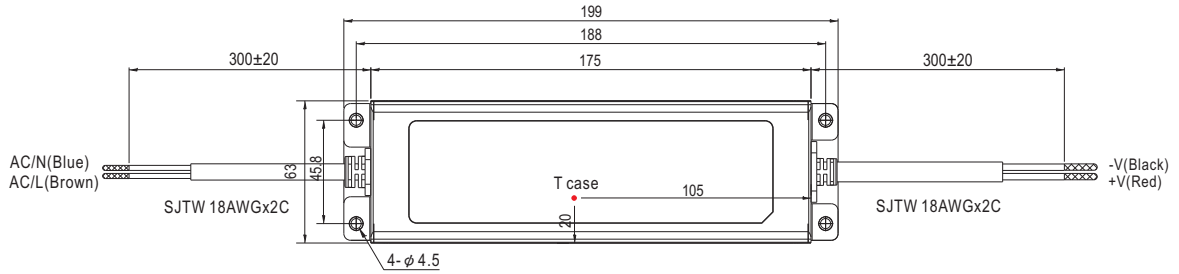

※ T case: Max. Case Temperature.



A-Type:(ELG-100-_A)

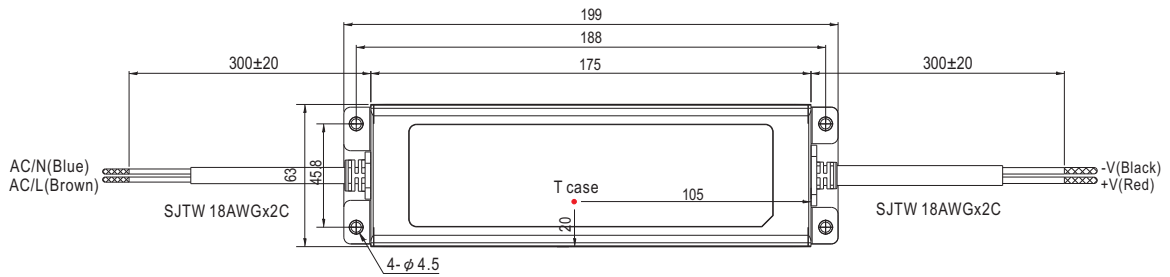

※ T case: Max. Case Temperature.

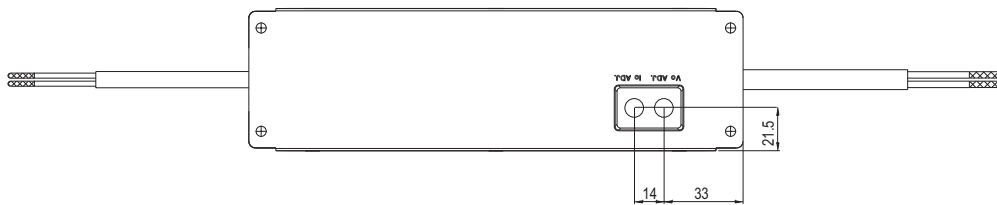

B-Type/DA-Type:(ELG-100-_B/ELG-100-_DA)

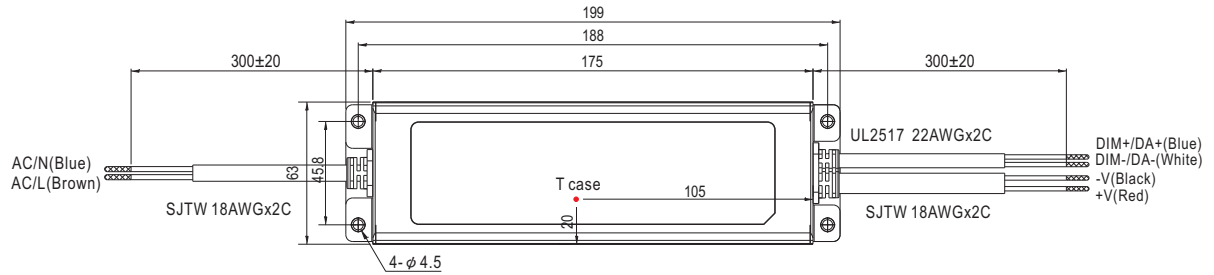

※ T case: Max. Case Temperature.

■ **Installation Manual**

Please refer to : <http://www.meanwell.com/webnet/search/InstallationSearch.html>